



9 1 1 3

Temperatur- /
mA-konverter

No. 9113V106-DK

Produktversion: 9113-004



- DK** ▶ PR electronics A/S tilbyder et bredt program af analoge og digitale signalbehandlingsmoduler til industriel automation. Programmet består af Isolatorer, Displays, Ex-barrierer, Temperaturtransmittere, Universaltransmittere mfl. Vi har modulerne, du kan stole på i selv barske miljøer med elektrisk støj, vibrationer og temperaturudsving, og alle produkter opfylder de strengeste internationale standarder. Vores motto »Signals the Best« er indbegrebet af denne filosofi - og din garanti for kvalitet.
- UK** ▶ PR electronics A/S offers a wide range of analog and digital signal conditioning devices for industrial automation. The product range includes Isolators, Displays, I.S. Interfaces, Temperature Transmitters, and Universal Devices. You can trust our products in the most extreme environments with electrical noise, vibrations and temperature fluctuations, and all products comply with the most exacting international standards. »Signals the Best« is the epitome of our philosophy - and your guarantee for quality.
- FR** ▶ PR electronics A/S offre une large gamme de produits pour le traitement des signaux analogiques et numériques dans tous les domaines industriels. La gamme de produits s'étend des transmetteurs de température aux afficheurs, des isolateurs aux interfaces SI, jusqu'aux modules universels. Vous pouvez compter sur nos produits même dans les conditions d'utilisation sévères, p.ex. bruit électrique, vibrations et fluctuations de température. Tous nos produits sont conformes aux normes internationales les plus strictes. Notre devise »SIGNALS the BEST« c'est notre ligne de conduite - et pour vous l'assurance de la meilleure qualité.
- DE** ▶ PR electronics A/S verfügt über ein breites Produktprogramm an analogen und digitalen Signalverarbeitungsgeräte für die industrielle Automatisierung. Dieses Programm umfasst Displays, Temperaturtransmitter, Ex- und galvanische Signaltrenner, und Universalgeräte. Sie können unsere Geräte auch unter extremen Einsatzbedingungen wie elektrisches Rauschen, Erschütterungen und Temperaturschwingungen vertrauen, und alle Produkte von PR electronics werden in Übereinstimmung mit den strengsten internationalen Normen produziert. »Signals the Best« ist Ihre Garantie für Qualität!

TEMPERATUR- / mA-KONVERTER

9113

INDHOLDSFORTEGNELSE

Advarsel.....	2
Signaturforklaring.....	2
Sikkerhedsregler	2
Afmontering af system 9000.....	4
Avancerede features	5
Anvendelse.....	5
Teknisk karakteristik	5
Applikationer	6
PR 4501 Display- / programmeringsfront.....	7
Påsætning / aftagning af PR4501/4511.....	8
Bestillingsnumre for 9113B.....	9
Tilbehør.....	9
Elektriske specifikationer	9
Konfigurering af følerfejlscheck	14
Indgangssignal uden for område.....	14
Følerfejlsdetektering.....	14
Hardwarefejl.....	14
Tilslutninger.....	16
Blokdiagram	17
Visning af signal- og kabelfejl uden displayfront.....	18
Programmering / betjening af trykknapper	19
Rutediagram	22
Rutediagram, Avancerede indstillinger (ADV.SET).....	24
Rullende hjælpetekster i displaylinie 3.....	25
Appendix	26
IECEX Installation Drawing.....	27
ATEX Installation Drawing.....	30
FM Installation Drawing	33
INMETRO Installation Drawing	36
Safety Manual.....	39



ADVARSEL

Følgende operationer bør kun udføres på modulet i spændingsløs tilstand og under ESD-sikre forhold:

Installation, ledningsmontage og -demontage.

Fejlfinding på modulet.

Reparation af modulet og udskiftning af sikringer må kun foretages af PR electronics A/S.



ADVARSEL

Modulets frontplade må ikke åbnes, da dette vil medføre skade på stikforbindelsen til display- / programmeringsfronten PR 4501. Modulet indeholder ingen DIP-switcher eller jumbere.

SIGNATURFORKLARING



Trekant med udråbstegn: Læs manualen før installation og idriftsættelse af modulet for at undgå hændelser, der kan føre til skade på personer eller materiel.



CE-mærket er det synlige tegn på modulets overensstemmelse med EU-direktivernes krav.



Dobbelt isolation er symbolet for, at modulet overholder ekstra krav til isolation.



Ex - Modulet er godkendt efter ATEX-direktivet til brug i forbindelse med installationer i eksplosionsfarlige områder.

SIKKERHEDSREGLER

DEFINITIONER

Farlige spændinger er defineret som områderne: 75...1500 Volt DC og 50...1000 Volt AC.

Teknikere er kvalificerede personer, som er uddannet eller oplært til at kunne udføre installation, betjening eller evt. fejlfinding både teknisk og sikkerhedsmæssigt forsvarligt.

Operatører er personer, som under normal drift med produktet skal indstille og betjene produktets trykknapper eller potentiometre, og som er gjort bekendt med indholdet af denne manual.

MODTAGELSE OG UDPAKNING

Udpak modulet uden at beskadige det. Kontrollér ved modtagelsen, at modul-typen svarer til den bestilte. Indpakningen bør følge modulet, indtil dette er monteret på blivende plads.

MILJØFORHOLD

Undgå direkte sollys, kraftigt støv eller varme, mekaniske rystelser og stød, og udsæt ikke modulet for regn eller kraftig fugt. Om nødvendigt skal opvarmning, ud over de opgivne grænser for omgivelsestemperatur, forhindres ved hjælp af ventilation.

Modulet skal installeres i forureningsgrad 2 eller bedre.

Modulet er designet til at være sikkert mindst op til en højde af 2000 m.

INSTALLATION

Modulet må kun tilsluttes af teknikere, som er bekendte med de tekniske udtryk, advarsler og instruktioner i manualen, og som vil følge disse.

Hvis der er tvivl om modulets rette håndtering, skal der rettes henvendelse til den lokale forhandler eller alternativt direkte til:

PR electronics A/S
www.prelectronics.dk

Det er ikke tilladt at benytte flerkoret ledning ved tilslutning af forsynings-spænding med mindre ledningsenderne er forsynet med ledningstykker.

Beskrivelse af indgang / udgang og forsyningsforbindelser findes på blokdiagrammet og sideskiltet.

Modulet er forsynet med skrueterminaler og skal forsynes fra en dobbeltisoleret / forstærket isoleret spændingsforsyning. En afbryder placeres let tilgængeligt og tæt ved modulet. Afbryderen skal mærkes således, at der ikke er tvivl om, at den afbryder spændingen til modulet.

Ved installation på Power Rail 9400 bliver forsynings-spændingen leveret af Power Control Unit type 9410.

Produktionsår fremgår af de to første cifre i serienummeret.

KALIBRERING OG JUSTERING

Under kalibrering og justering skal måling og tilslutning af eksterne spændinger udføres i henhold til denne manual, og teknikeren skal benytte sikkerhedsmæssigt korrekte værktøjer og instrumenter.

BETJENING UNDER NORMAL DRIFT

Operatører må kun indstille eller betjene modulerne, når disse er fast installeret på forsvarlig måde i tavler el. lignende, så betjeningen ikke medfører fare for liv eller materiel. Dvs., at der ikke er berøringsfare, og at modulet er placeret, så det er let at betjene.

RENGØRING

Modulet må, i spændingsløs tilstand, rengøres med en klud let fugtet med destilleret vand.

ANSVAR

I det omfang instruktionerne i denne manual ikke er nøje overholdt, vil kunden ikke kunne rette noget krav, som ellers måtte eksistere i henhold til den indgåede salgsaftale, mod PR electronics A/S.

AFMONTERING AF SYSTEM 9000

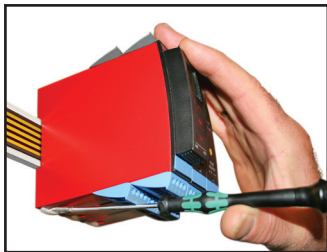

Billede 1:

Modulet frigøres fra DIN-skinnen ved at løfte i den nederste lås.

TEMPERATUR- / mA-KONVERTER

9113

- *Indgang for RTD, TC og mA*
- *Aktiv / passiv mA-udgang*
- *1 eller 2 kanaler*
- *Kan forsynes separat eller installeres på power rail, PR type 9400*
- *SIL 2-certificeret via Full Assessment*

Avancerede features

- Konfiguration og monitorering via aftagelig displayfront (PR 4501); proceskalibrering og signalsimulering.
- Kopiering af opsætningen fra et modul til andre af samme type via displayfronten.
- TC-indgange kan anvende enten intern CJC eller en klemme med indbygget Pt100-føler (PR 5910Ex, kanal 1 / PR 5913Ex, kanal 2) for højere nøjagtighed.
- 9113 detekterer automatisk, om modulet skal levere et aktivt eller et passivt strømsignal.
- Avanceret monitorering af intern kommunikation og gemte data.
- SIL 2-funktionaliteten skal aktivt tilvælges via menupunkt.

Anvendelse

- 9113 kan monteres i sikkert område samt i zone 2 / division 2 og modtage signaler fra zone 0, 1, 2, 20, 21, 22, inklusiv M1 / Class I/II/III, Div. 1, Gr. A-G.
- Konvertering og skalering af temperatursignaler (Pt, Ni og TC) og aktive strøm-signaler.
- 9113 er konstrueret, udviklet og certificeret til brug i SIL 2-installationer iht. kravene i IEC 61508.

Teknisk karakteristik

- 1 grøn og 2 røde LEDs i front indikerer normal drift og funktionsfejl.
- 2,6 kVAC galvanisk isolation mellem indgang / udgang / forsyning.



APPLIKATIONER

Indgangssignaler:

Kanal 1:
Strøm

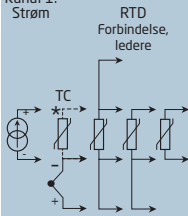

*Bestilles særskilt: CJC-klemme 5910Ex / 5913Ex

Udgangssignaler:

Analog, 0/4...20 mA

Kanal 2:

2-trådsforsyning -

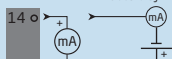

Kanal 1:

2-trådsforsyning -

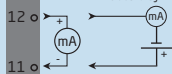

Power rail

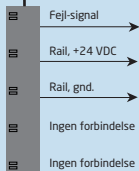

Kanal 2:
Strøm

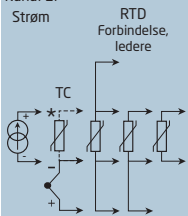

*Bestilles særskilt: CJC-klemme 5910Ex / 5913Ex

Forsyningsspændinger:

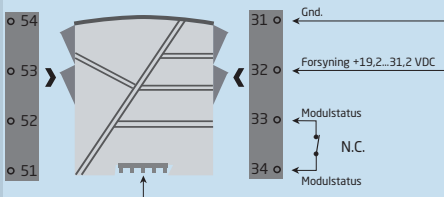

Forsyning via
power rail

**Zone 0, 1, 2,
20, 21, 22, M1 &
Cl. I/II/III, Div. 1
gr. A-G**

Zone 2 / Cl. 1, div. 2, gr. A-D eller sikkert område

PR 4501 DISPLAY- / PROGRAMMERINGSFRONT



Funktionalitet

Den enkle menustruktur og de forklarende hjælpetekster leder dig automatisk gennem opsætningen, og gør produktet meget enkelt at anvende. Se beskrivelse af funktioner og opsætningsmuligheder under afsnittet "Programmering / betjening af trykknapper".

Anvendelse

- Kommunikationsinterface til ændring af driftsparametre i 9113.
- Kan flyttes fra en 9113 til en anden 9113 og downloade opsætningen fra det første modul til andre af samme type.
- Som fastmonteret display til visualisering af procesdata og status.

Teknisk karakteristik

- Fire liniers LCD-display, linie 1 (5,57 mm høj) viser indgangsstatus, linie 2 og 3 (3,33 mm høje) viser analog indgangs- / udgangsværdi eller TAG-nr samt enheder - UNIT, og linie 4 viser status for kommunikation og SIL-lås. Statisk prik = SIL-låst og blinkende prik = ikke SIL-låst.
- Programmeringsadgang kan forhindres ved indkodning af et password. Passwordet gemmes i transmitteren, så sikkerheden mod uønskede ændringer er så høj som muligt.

PÅSÆTNING / AFTAGNING AF PR4501/4511

1: Indsæt tappene på 4501/4511 i hullerne øverst på modulet.

2: Sving 4501/4511 på plads.

Aftagning af 4501/4511

3: Tryk på udløserknop i bunden af 4501/4511 og sving 4501/4511 op.

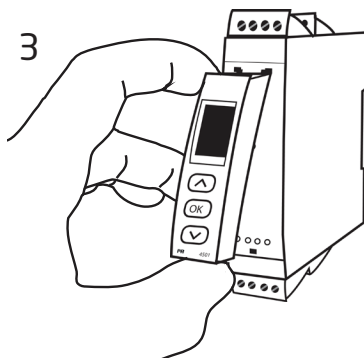
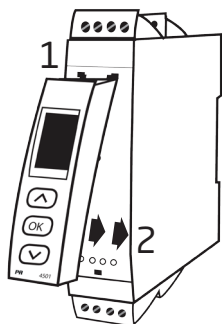

Bestillingsnumre for 9113B

Type	Kanaler
9113B	Enkelt : A Dobbelt : B

Tilbehør

4501 = Display- / programmeringsfront
4511 = Kommunikationsenhed
5910Ex = CJC-klemme, kanal 1
5913Ex = CJC-klemme, kanal 2
9400 = Power rail
9404 = Modulstop til rail
9410 = Power control unit
9420 = Spændingsforsyning 24 V / 120 W - Ex nAC

Elektriske specifikationer

Omgivelsesbetingelser

Specifikationsområde.....	-20...+60°C
Lagringstemperatur	-20...+85°C
Kalibreringstemperatur	20...28°C
Relativ luftfugtighed	< 95% RH (ikke kond.)
Kapslingsklasse	IP20
Installation i	Forureningsgrad 2 & måle- / overspændingskategori II

Mekaniske specifikationer

Mål, uden displayfront (HxBxD).....	109 x 23,5 x 104 mm
Mål, med 4501 / 4511 (HxBxD).....	109 x 23,5 x 116 / 131 mm
Vægt, ca.....	250 g
Vægt inkl. 4501 / 4511 (ca.).....	265 g / 350 g
DIN-skinnetype.....	DIN EN 60715 / 35 mm
Ledningskvadrat (min. / max.).....	0,13...2,08 mm ² / AWG 26...14 flerkoret ledning
Klemskruetilspændingsmoment.....	0,5 Nm
Vibration.....	IEC 60068-2-6 : 2007
Vibration: 2...13,2 Hz.....	±1 mm
Vibration: 13,2...100 Hz.....	±0,7 g

Fælles specifikationer:

Forsyningsspænding, DC.....	19,2...31,2 VDC
Max. forbrug.....	≤ 3,5 W (2 kanaler)

Sikring.....	400 mA T / 250 VAC
Isolationsspændinger, test / drift	
Indgang til alle.....	2,6 kVAC / 300 VAC forstærket
Analog udgang til forsyning.....	2,6 kVAC / 300 VAC forstærket
Statusrelæ til forsyning.....	1,5 kVAC / 150 VAC forstærket
Kommunikationsinterface	Kommunikationsenhed 4511 Programmeringsfront 4501
Signal- / støjforhold.....	Min. 60 dB (0...100 kHz)
Gennemsnitlig reaktionstid inkl. forsinkelse:	
Temperaturindgang.....	≤ 1 s
mA-indgang.....	≤ 0,4 s
Nøjagtighed, størst af generelle og basisværdier:	

Generelle værdier		
Indgangs- type	Absolut nøjagtighed	Temperatur- koefficient
Alle	≤ ±0,1% af span	≤ ±0,01% af span / °C

Basisværdier		
Indgangs- type	Basis- nøjagtighed	Temperatur- koefficient
mA	≤ ±16 µA	≤ ±1,6 µA / °C
Pt100, Pt200, Pt 1000	≤ ±0,2°C	≤ ±0,02°C / °C
Pt500, Ni100, Ni120, Ni 1000	≤ ±0,3°C	≤ ±0,03°C / °C
Pt50, Pt400, Ni50	≤ ±0,4°C	≤ ±0,04°C / °C
Pt250, Pt300	≤ ±0,6°C	≤ ±0,06°C / °C
Pt20	≤ ±0,8°C	≤ ±0,08°C / °C
Pt10	≤ ±1,4°C	≤ ±0,14°C / °C
TC-type: E, J, K, L, N, T, U	≤ ±1°C	≤ ±0,1°C / °C
TC-type: R, S, W3, W5, LR	≤ ±2°C	≤ ±0,2°C / °C
TC-type: B 160...400°C	≤ ±4,5°C	≤ ±0,45°C / °C
TC-type: B 400...1820°C	≤ ±2°C	≤ ±0,2°C / °C

EMC-immunitetspåvirkning.....	< ±0,5% af span
Udvidet EMC-immunitet:	
NAMUR NE 21, A-kriterium, gniststøj.....	< ±1% af span

RTD-indgang:

Indgangs-type	Min. værdi	Max. værdi	Standard
Pt100 Ni100	-200°C -60°C	+850°C +250°C	IEC60751 DIN 43760

Indgang for RTD-typer:

Pt10*, Pt20*, Pt50*, Pt100, Pt200, Pt250, Pt300, Pt400, Pt500, Pt1000
Ni50, Ni100, Ni120, Ni1000

Kabelmodstand pr. leder, (max.)..... 50 Ω

Følerstrøm, RTD..... Nom. 0,2 mA

Virkning af følerkabelmodstand

(3- / 4-leder), RTD..... < 0,002 Ω / Ω

Følerfejlsdetektering, RTD..... Programmerbar ON / OFF

Følerfejlsstrøm:

under detektering..... < 2 µA

ellers..... 0 µA

* Ingen kortslutningsdetektering for Pt10, Pt20 og Pt50

TC-indgang:

Type	Min. værdi	Max. værdi	Standard
B	0°C	+1820°C	IEC 60584-1
E	-100°C	+1000°C	IEC 60584-1
J	-100°C	+1200°C	IEC 60584-1
K	-180°C	+1372°C	IEC 60584-1
L	-200°C	+900°C	DIN 43710
N	-180°C	+1300°C	IEC 60584-1
R	-50°C	+1760°C	IEC 60584-1
S	-50°C	+1760°C	IEC 60584-1
T	-200°C	+400°C	IEC 60584-1
U	-200°C	+600°C	DIN 43710
W3	0°C	+2300°C	ASTM E988-90
W5	0°C	+2300°C	ASTM E988-90
LR	-200°C	+800°C	GOST 3044-84

Koldt loddestedskomp. (CJC):	
via ekstern føler i klemme 5910	20...28°C ≤ ± 1°C -20...20°C og 28...70°C ≤ ± 2°C
via intern CJC-føler	±(2,0°C + 0,4°C * Δt)
Δt = intern temperatur - omgivelsestemperatur	
Følerfejlsdetektering.....	Programmerbar ON eller OFF (kun kabelbrud)
Følerfejlstrøm:	
under detektering.....	Nom. 2 µA
ellers.....	0 µA
Strømindgang:	
Måleområde.....	0...20 mA
Programmerbare måleområder.....	0...20 og 4...20 mA
Indgangsmodstand	Nom. 20 Ω + PTC 50 Ω
Følerfejlsdetektering.....	Programmerbar ON / OFF Kun 4...20 mA (NAMUR)
Strømodgang:	
Signalområde (span).....	0...20 mA
Programmerbare signalområder	0...20 / 4...20 / 20...0 og 20...4 mA
Belastning (max.).....	20 mA / 600 Ω / 12 VDC
Belastningsstabilitet	≤ 0,01% af span / 100 Ω
Følerfejlsdetektering.....	0 / 3,5 / 23 mA / ingen
NAMUR NE 43 Up- / Downscale	23 mA / 3,5 mA
Begrænsning af udgang:	
på 4...20 og 20...4 mA signaler.....	3,8...20,5 mA
på 0...20 og 20...0 mA signaler.....	0...20,5 mA
Strømbegrænsning.....	≤ 28 mA
2-tråds 4...20 mA udgang:	
Signalområde.....	4...20 mA
Belastningsstabilitet	≤ 0,01% af span / 100 Ω
Belastningsmodstand	≤ (V _{forsyn.} - 3,5) / 0,023 A [Ω]
Område for ekstern 2-trådsforsyning	3,5...26 VDC
Virkning af ekstern 2-trådsforsynings- spændingsændring.....	< 0,005% af span / V
Statusrelæ i sikkert område:	
Max. spænding.....	125 VAC / 110 VDC
Max. strøm	0,5 AAC / 0,3 ADC
Max. effekt	62,5 VA / 32 W

af span = af det aktuelt valgte måleområde

Godkendelser:

EMC 2004/108/EF	EN 61326-1
LVD 2006/95/EF	EN 61010-1
UL, Standard for Safety	UL 61010-1
EAC TR-CU 020/2011.....	EN 61326-1

Marine:

Det Norske Veritas, Ships & Offshore Stand. f. Certific. No. 2.4

I.S. / Ex:

ATEX 94/9/EF	KEMA 07ATEX0148 X
IECEX	IECEX KEM 09.0052X
c FM us	3038279-C
INMETRO	NCC 12.1310 X
CCOE	P337349/3
EAC Ex TR-CU 012/2011	RU C-DK.GB08.V.00410

Funktionel sikkerhed:

SIL 2-certificeret via Full Assessment iht. IEC 61508

Konfigurering af følerfejlscheck

Følerfejlscheck:		
Modul:	Konfiguration	Følerfejlsdetektering:
9113	OUT.ERR=NONE.	OFF
	Ellers:	ON

Displayvisning på 4501 af: Indgangssignal uden for område

Uden for område visning (IN.LO, IN.HI): Ved overskridelse af A/D-konverterens eller polynomiets gyldige område			
Indgang	Område	Visning	Grænse
CURR	0...20 mA / 4...20 mA	IN.LO	< -1,05 mA
		IN.HI	> 25,05 mA
TEMP	TC / RTD	IN.LO	< temperaturområde -2°C
		IN.HI	> temperaturområde +2°C

Display under min.- / over max.-visning (-1999, 9999):			
Indgang	Område	Visning	Grænse
Alle	Alle	-1999	Displayværdi < -1999
		9999	Displayværdi > 9999

Følerfejlsdetektering

Sensor error detection (SE.BR, SE.SH):			
Indgang	Område	Visning	Grænse
CURR	Strømsløjfebrud (4...20 mA)	SE.BR	< = 3,6 mA; > = 20,75 mA
TEMP	TC	SE.BR	> 10 kΩ...165 kΩ
		SE.SH	< ca. 15 Ω
	RTD: 2-, 3- og 4-leder For Pt10, Pt20, Pt50, Pt100, Pt200, Ni50 og Ni120	SE.BR	> 900...1000 Ω (kabel > 50 Ω)
		SE.SH	< ca. 15 Ω
RTD: 2-, 3- og 4-leder for Pt250, Pt300, Pt400, Pt500, Pt1000 og Ni1000	SE.BR	> 10...12 kΩ (kabel > 50 Ω)	
	SE.SH	< ca. 15 Ω	

Hardwarefejl

Visning ved hardwarefejl		
Fejlsøgning	Visning	Årsag
Indgang uden for område (lavt indgangssignal)	IN.LO	Se grænser ovenfor
Indgang uden for område (højt indgangssignal)	IN.HI	Se grænser ovenfor
Føler kabelbrud	SE.BR	Se grænser ovenfor
Føler kortslutning	SE.SH	Se grænser ovenfor
Test af intern CJC-føler	CJ.ER	Intern CJC-føler defekt eller CJC-temperatur uden for område**
CJC-klemme fejl - check CJC-terminal	CJ.CE	Defekt eller manglende CJC-klemme, temperatur uden for gyldigt område

Visning ved hardwarefejl		
Fejlsøgning	Visning	Årsag
Fejl på indgangen - check indgangsforbindelser samt sluk og tænd for modulet	IN.ER	Signalniveauer på indgang uden for grænser eller forbundet til forkerte terminaler*
Fejl på udgangen - check udgangsforbindelser samt sluk og tænd for modulet	AO.ER	Fejl i analog udgangsstrøm (kun for SIL-mode)*
Ingen kommunikation	NO.CO	Ingen kommunikation med (4501)
Fejl i flash - check konfigurationen	FL.ER CO.ER	Fejl i FLASH (ugyldig konfiguration)***
Ugyldig konfigurationstype eller ugyldig version	TY.ER	Konfiguration hentet fra EEprom har ugyldigt type- eller revisionsnummer
Hardwarefejl	RA.ER	Fejl i RAM*
Hardwarefejl	IF.ER	Fejl i intern Flash*
Hardwarefejl	SW.ER	Fejl i SW monitor*
Hardwarefejl	AD.ER	Fejl i A/D-konverter*
Hardwarefejl	AO.SU	Fejl i analog udgangsforsyning*
Hardwarefejl	CA.ER	Fejl i fabrikskalibrering*
Hardwarefejl	CM.ER	Fejl i primær CPU*
Hardwarefejl	II.ER	Fejl i initialiseringscheck*
Hardwarefejl	RS.ER	Reset-fejl*
Hardwarefejl	IC.ER	Fejl i kommunikation på indg.*
Hardwarefejl	M1.ER	Fejl fra primær CPU til kanal 1*
Hardwarefejl	M2.ER	Fejl fra primær CPU til kanal 2*
Hardwarefejl	MC.ER	Konfig.-fejl i primær CPU*
Hardwarefejl	MF.ER	Flash-fejl i primær CPU*
Hardwarefejl	MR.ER	RAM-fejl i primær CPU*
Hardwarefejl	MS.ER	Fejl i forsyning til primær CPU*
Hardwarefejl	MP.ER	ProgFlow-fejl i primær CPU*

! Alle fejlvisninger i display blinker 1 gang pr. sekund samt suppleres med tilhørende hjælpetekst.

* Fejlen kan resettes ved at steppe igennem menuerne eller ved at slukke og tænde for modulet.

Nogle fejltypen kan kun resettes ved at slukke og tænde for modulet.

** Fejlen kan resettes ved at steppe igennem menuerne eller ved at slukke og tænde for modulet.

Fejlen kan tilsidesættes ved at vælge en anden indgangstype end TC.

*** Fejlen kan resettes ved at steppe igennem menuerne.

TILSLUTNINGER

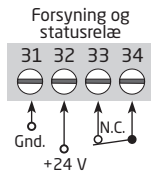
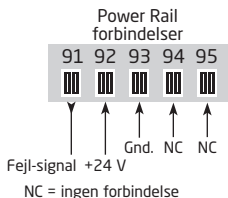

Indgange

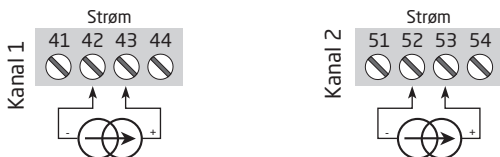
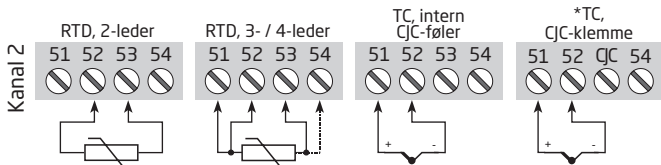
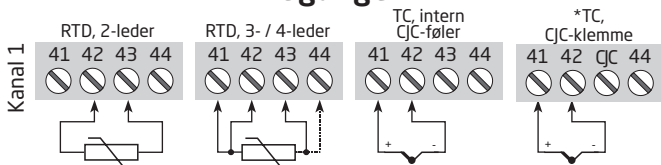

* Bestilles særskilt: CJC-klemme 5910Ex (kanal 1) / 5913Ex (kanal 2).

Udgange:

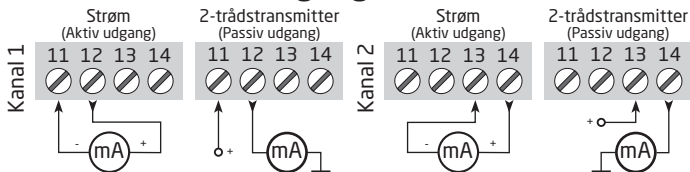

BLOKDIAGRAM

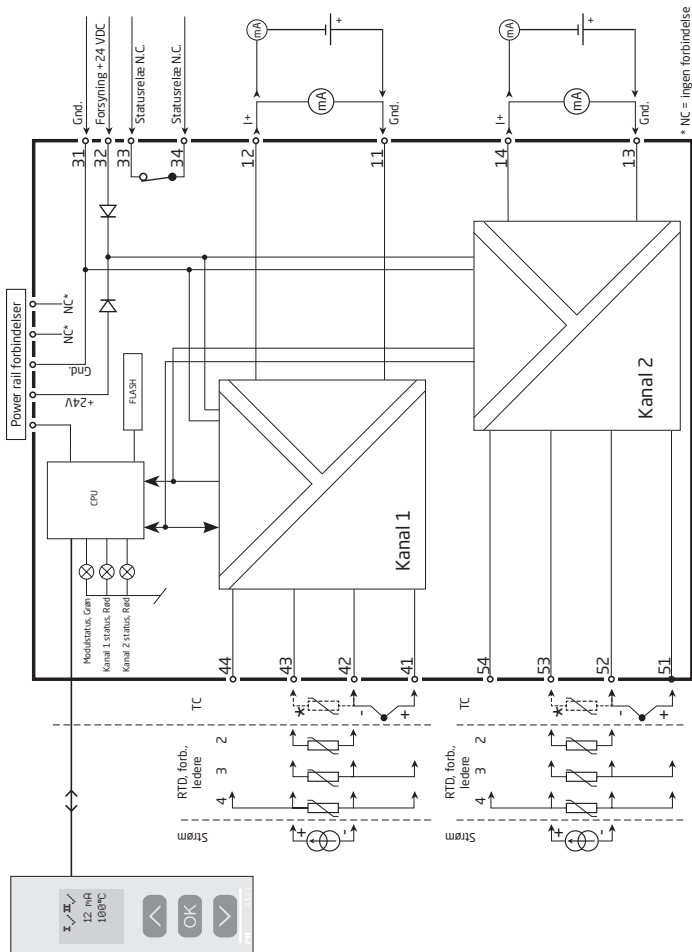

9113

* NC = ingen forbindelse

Visning af signal- og kabelfejl uden displayfront

Liste over LED- og fejlsignalvisninger						
Tilstand	Grøn LED	Kanal 1: Rød LED	Kanal 2: Rød LED	Statusrelæ, N.C.	Power rail signalstatus	
Modul OK	Blinker	OFF	OFF	Trukket	Åben	
Ingen forsyning	OFF	OFF	OFF	Sluppet	Lukket	
Modul defekt	OFF	ON	ON	Sluppet	Lukket	
Kanal 1 defekt (kanal 2 OK)	Blinker	ON	OFF	Sluppet	Lukket	
Kanal 2 defekt (kanal 1 OK)	Blinker	OFF	ON	Sluppet	Lukket	
Kanal 1, signal OK	Blinker	OFF	OFF	Trukket	Åben	
Kanal 1, kabelkortslutning / kabelbrud	Blinker	Blinker	OFF	Sluppet	Lukket (hvis aktiveret)	
Kanal 2, signal OK	Blinker	OFF	OFF	Trukket	Åben	
Kanal 2, kabelkortslutning / kabelbrud	Blinker	OFF	Blinker	Sluppet	Lukket (hvis aktiveret)	

PROGRAMMERING / BETJENING AF TRYKKNAPPER

Dokumentation til rutediagram

Generelt

Når du skal konfigurere 9113, bliver du guidet igennem samtlige parametre og kan vælge netop de indstillinger, der passer til applikationen. Til hver menu findes en rullende hjælpetekst, som vises i displaylinie 3.

Konfigurationen udføres ved hjælp af de 3 taster:

- ⬆ forøger talværdien eller vælger næste parameter
- ⬇ formindsker talværdien eller vælger forrige parameter
- OK accepterer valget og går til næste menu

Når konfigurationen er gennemført, returneres til normaltilstand 1.0.

Tryk og hold OK tasten nede for at gå til forrige menu eller normaltilstand (1.0) uden at gemme de ændrede tal eller parametre.

Hvis ingen taster har været aktiveret i 1 minut, returnerer displayet til normaltilstand (1.0) uden at gemme de ændrede tal eller parametre.

Uddybende forklaringer

Passwordbeskyttelse: Programmeringsadgang kan forhindres ved indkodning af et password. Passwordet gemmes i konverteren, så sikkerheden mod uønskede ændringer er så høj som muligt. Default password 2008 giver adgang til alle programmeringsmenuer.

Valg af units

Ved valg af temperaturindgang kan man vælge, hvilke procesenheder der skal vises i displayet (se skema). Procesværdien altid i Celsius eller Fahrenheit. Vælges i menupunktet efter valg af temperaturindgang.

CJC

Det er via menuen CJC muligt at vælge mellem ekstern CJC-klemme, og intern CJC-kompensering. CJC-klemme (PR 5910Ex/PR 5913Ex) bestilles særskilt.

Signal- og følerfejlsinformation via displayfront 4501

Følerfejl (se grænser i skema) vises i display med SE.BR (sensor break) eller SE.SH (sensor short). Signaler uden for det valgte område (ikke følerfejl, se skema for grænser) vises i display som IN.LO (lavt indgangssignal) eller IN.HI (højt indgangssignal).

Fejlindikeringen vises i tekst i 2. linie for kanal 1 og 3. linie for kanal 2, samtidig med at baggrundsbelysningen blinker. 4. linie i displayet er en statuslinie, der viser, om modulet er SIL-låst (statisk prik = SIL-låst og blinkende prik = ikke SIL-låst) og status for kommunikation COM (prik med løbende cirkel) som indikerer, om 4501 fungerer korrekt.

Signal- og følerfejsindikering uden displayfront:

Status på enheden kan aflæses på de 3 LED's i fronten af modulet.

Grøn blinkende LED indikerer normal drift.

Ingen lys i grøn LED indikerer manglende forsyningsspænding eller modulfejl.

Konstant rød LED indikerer fatal fejl.

Rød blinkende LED indikerer følerfejl.

Avancerede funktioner

Enheden giver adgang til en række avancerede funktioner, der nås ved at svare "YES" til punktet "ADV.SET".

Display setup: Her kan man justere kontrast og baggrundsbelysning. Opsætning af TAG-nummer med 5 alfanumeriske karakterer. Valg af funktionsvisning i linie 2 og 3 på displayet, der vælges mellem visning af analog indgang, analog udgang og TAG-nummer eller vekslende displayvisning.

2-punkts proceskalibrering: Enheden kan proceskalibreres til et aktuelt indgangssignal i 2 punkter. Der påtrykkes et lavt indgangssignal (ikke nødvendigvis 0%), og den aktuelle værdi angives. Herefter påtrykkes et højt signal (ikke nødvendigvis 100%), og den aktuelle værdi angives. Såfremt man siger ja til at bruge kalibreringen, vil enheden herefter arbejde i henhold til denne nye justering. Siger man senere nej i dette punkt eller vælger en anden indgangssignaltyp, går enheden tilbage til fabrikskalibreringen.

Processimulerings-funktion: Vælger man ja til punktet "EN.SIM", er det muligt med piltasterne at simulere et indgangssignal og dermed styre udgangssignalet op og ned. SIM-menuen skal forlades ved at trykke **OK** (ingen time-out). Hvis 4501 fjernes, afbrydes processimuleringen.

Password: Her kan vælges et password mellem 0000 og 9999 til beskyttelse mod uautoriserede ændringer. Enheden leveres default uden password.

Sprog: Der kan i menuen "LANG" vælges mellem 7 forskellige sprogvarianter af hjælpetekster, der fremkommer i menuen. Der kan vælges mellem UK, DE, FR, IT, ES, SE og DK.

Power rail: I menuen "RAIL" vælges om følerfejl skal overføres til en central overvågning i PR 9410 power control unit.

Safety Integrity Level: Se Safety Manual for yderligere information.



RUTEDIAGRAM

Power up

1.0

- 1.0 = Normaltilstand. Linie 1 viser indgangsstatus, linie 2 og 3 (3,33 mm høje) viser analog indgangs- / udgangs-værdi eller TAG-nr. samt enheder - UNIT, og linie 4 viser status for kommunikation og SIL-lås. Statisk prik = SIL-låst og blinkende prik = ikke SIL-låst.
- 1.1 = Kun hvis beskyttet med password
- 1.2 = Gælder ikke for 0...20 mA indgangssignal.
- 1.3 = Kun hvis indgangssignalet er temperatur. Min. og max. iht. valgt følerstype.
- 1.4 = Kun hvis opsætning ikke er beskyttet med password.

Rød tekst viser safety parametre i en SIL-konfiguration. Se Safety Manual for yderligere information.

Hvis ingen taster har været aktiveret i 1 minut, returnerer displayet til normaltilstanden 1.0 uden at gemme eventuelle konfigurationsændringer.

- ⊗ Forøgelse af værdi / vælg næste parameter
 - ⊕ Formindskelse af værdi / vælg forrige parameter
 - ⊙ Accepter valget og gå til næste menu
- Holdte ⊙ går til forrige menu / returnerer til 1.0 uden at gemme

Holdte ⊙ går til forrige menu / returnerer til 1.0 uden at gemme

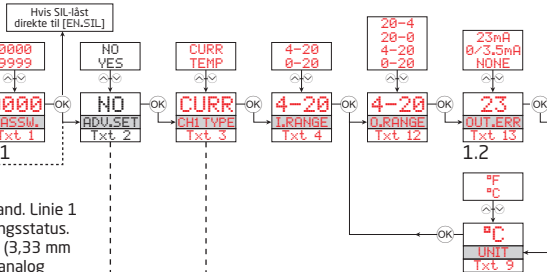

YES
ADU.SET
Txt 2

OK → Fortsættes på siden
Rutediagram ADV.SET

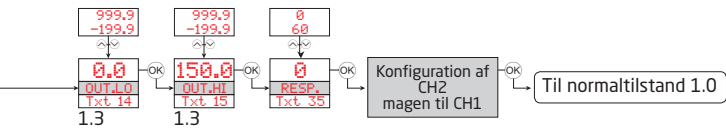

RUTEDIAGRAM, AVANCEREDE INDSTILLINGER (ADV.SET)

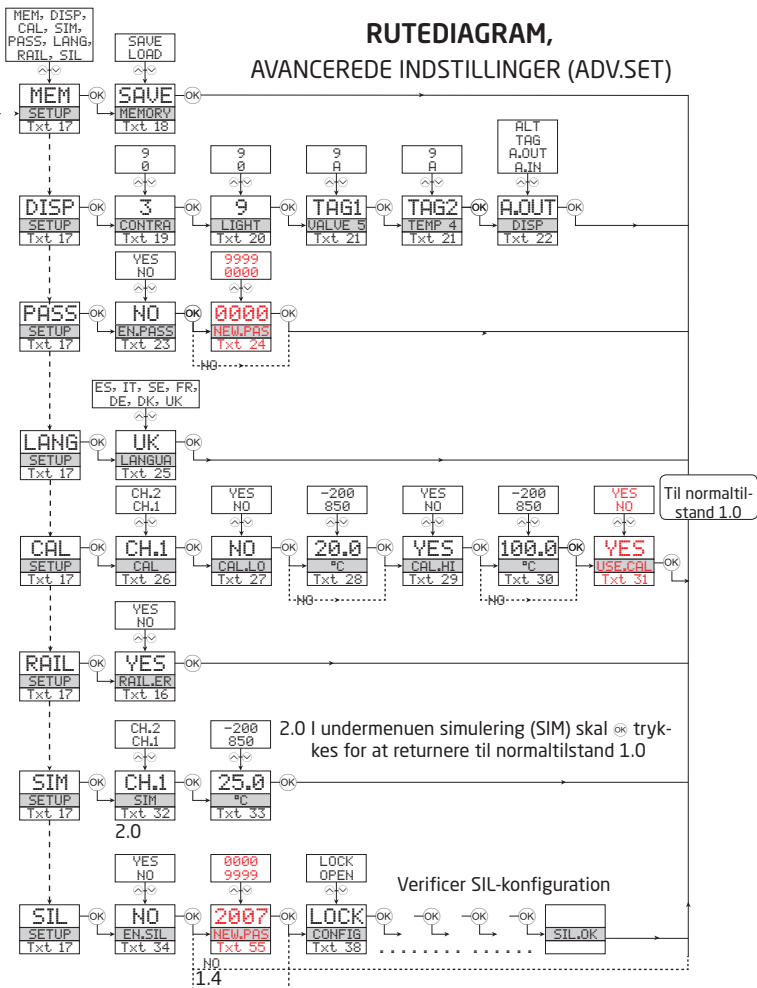

RULLENDE HJÆLPETEKSTER I DISPLAYLINIE 3

- [01] Angiv korrekt password
[02] Gå til avanceret opsætningsmenu?
[03] Vælg temperaturindgang
Vælg strømindgang
[04] Vælg 0-20 mA indgangsområde
Vælg 4-20 mA indgangsområde
[05] Vælg TC-følertype
Vælg Ni-følertype
Vælg Pt-følertype
[06] Vælg Pt10 som følertype
Vælg Pt20 som følertype
Vælg Pt50 som følertype
Vælg Pt100 som følertype
Vælg Pt200 som følertype
Vælg Pt250 som følertype
Vælg Pt300 som følertype
Vælg Pt400 som følertype
Vælg Pt500 som følertype
Vælg Pt1000 som følertype
[07] Vælg Ni50 som følertype
Vælg Ni100 som følertype
Vælg Ni120 som følertype
Vælg Ni1000 som følertype
[08] Vælg TC-B som følertype
Vælg TC-E som følertype
Vælg TC-J som følertype
Vælg TC-K som følertype
Vælg TC-L som følertype
Vælg TC-N som følertype
Vælg TC-R som følertype
Vælg TC-S som følertype
Vælg TC-T som følertype
Vælg TC-U som følertype
Vælg TC-W3 som følertype
Vælg TC-W5 som følertype
Vælg TC-LR som følertype
[09] Vælg 2-leder følertilslutning
Vælg 3-leder følertilslutning
Vælg 4-leder følertilslutning
[11] Vælg Celsius som temperaturenhed
Vælg Fahrenheit som temperaturenhed
[12] Vælg 0-20 mA udgangsområde
Vælg 4-20 mA udgangsområde
Vælg 20-0 mA udgangsområde
Vælg 20-4 mA udgangsområde
[13] Vælg ingen fejlaktion - udgang udefineret ved fejl
Vælg downscale ved fejl
Vælg NAMUR NE43 downscale ved fejl
Vælg NAMUR NE43 upscale ved fejl
[14] Indstil temperatur for analog udgang lav
[15] Indstil temperatur for analog udgang høj
[16] Vælg om fejl skal sendes til Rail
[17] Gå til valg af SIL låsning
Gå til simuleringsstilstand
Gå til valg af fejl til RAIL
Udfør proceskalibrering
Gå til valg af sprog
Gå til password-indstilling
Gå til displayopsætning
Udfør memory-operationer
[18] Overfør gemt opsætning til 9113
Gem 9113-opsætning i 4501
[19] Juster LCD-kontrast
[20] Juster LCD-baggrundsbelysning
[21] Angiv TAG-nr. - udfyld alle pladser
[22] Analog indgangsværdi vises i display
Analog udgangsværdi vises i display
TAG-nr. vises i display
Skift displayvisning mellem analogværdi og tag
[23] Vælg passwordbeskyttelse?
[24] Angiv nyt password
[25] Vælg sprog
[26] Vælg kanal for proceskalibrering
[27] Kalibrer indgang lav til procesværdi?
[28] Indstil værdi for lavt kalibreringspunkt
[29] Kalibrer indgang høj til procesværdi?
[30] Indstil værdi for højt kalibreringspunkt
[31] Brug proceskalibreringsværdier?
[32] Vælg kanal til simulering
[33] Indstil simuleringsværdi for indgang
[34] Vælg at SIL-låse konfigurationen
0-20 mA er ikke gyldigt udgangsområde for drift i
SIL-låst tilstand
[35] Vælg responstid for analog udgang i sekunder
[36] Vælg Intern temperatur-føler
Vælg J/C-stik (tilbehør)
[37] ...Bruger kanalen proceskompenserede
kalibreringsdata?
[38] Konfigurationens SIL-status (åben / låst)
[40] Følerkabelbrud
[41] Følerkortslutning
[42] Indgang uden for min.-område
[43] Indgang uden for max.-område
[44] Fejl på indgang - kontroller indgangsforbindelser og
genstart enheden
[45] Fejl på udgang - kontroller udgangsforbindelser og
genstart enheden
[46] Fejl i FLASH - kontroller konfiguration
[47] Ugyldig konfiguration eller ugyldig version
[48] Hardware fejl
[49] J/C-følerfejl - kontroller enhedens temperatur
[50] J/C-følerfejl - kontroller J/C-stikterminal
[51] Ingen kommunikation

APPENDIX

IECEX Installation drawing
ATEX Installation drawing
FM Installation drawing
INMETRO Installation drawing
Safety manual

IECEx Installation drawing

9113

For safe installation of 9113B the following must be observed. The module shall only be installed by qualified personnel who are familiar with the national and international laws, directives and standards that apply to this area.

Year of manufacture can be taken from the first two digits in the serial number.

4501

For Installation in Zone 2 the following must be observed.

The 4501 programming module is to be used solely with PRelectronics modules. It is important that the module is undamaged and has not been altered or modified in any way. Only 4501 modules free of dust and moisture shall be installed.

IECEx Certificate:KEM 09.0052 X

Marking

[Ex ia Ga] IIC/IB/IIA

Ex nA nC IIC T4 Gc

[Ex ia Da] IIIC

[Ex ia Ma] I

Standards

IEC60079-15:2005, IEC60079-11:2011, IEC60079-0:2011

IEC60079-26:2006

Hazardous area
Zone 0,1,2, 20, 21, 22

Non Hazardous area
or Zone 2

$-20 \leq T_a \leq +60^{\circ}\text{C}$

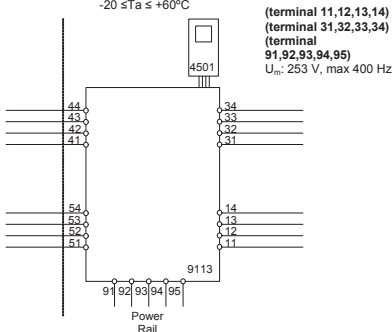

LERBAKKEN 10, 8410 RØNDE DENMARK

Ex input
CH1 (terminal 41,42,43,44)
CH2 (terminal 51,52,53,54)

U_o : 8.7 V
 I_o : 18.4 mA
 P_o : 40 mW
 L_o/R_o : 892 $\mu\text{H}/\Omega$

	IIC	IIB	IIA or I
C_o	5 μF	50 μF	1000 μF
L_o	100 mH	300 mH	700 mH

U_i : 10 V
 I_i : 30 mA
 C_i : 30 nF
 L_i : 820 nH

Status Relay. terminal (33,34)

Voltage max: 125 VAC / 110 VDC
 Power max: 62.5 VA / 32 W
 Current max: 0.5 A AC / 0.3 ADC

Zone 2 installation:

Voltage max: 32 VAC / 32 VDC
 Power max: 16 VA / 32 W
 Current max: 0.5 A AC / 1 ADC

Installation notes:

Install in pollution degree 2, overvoltage category II as defined in IEC60664-1

Do not separate connectors when energized and an explosive gas mixture is present.

Do not mount or remove modules from the Power Rail when an explosive gas mixture is present.

Disconnect power before servicing.

The wiring of unused terminals is not allowed.

In type of protection [Ex ia Da] the parameters for intrinsic safety for gas group IIB are applicable.

For installation in Zone 2, the module shall be installed in an enclosure in type of protection Ex n or Ex e, providing a degree of protection of at least IP54. Cable entry devices and blanking elements shall fulfill the same requirements.

For installation on Power Rail in Zone 2, only Power Rail type 9400 supplied by Power Control Unit type 9410 (Type Examination Certificate KEMA 07ATEX0152 X) is allowed.

LERBAKKEN 10, 8410 RØNDE DENMARK

Hazardous area
Zone 0,1,2, 20, 21, 22

Non Hazardous area
or Zone 2

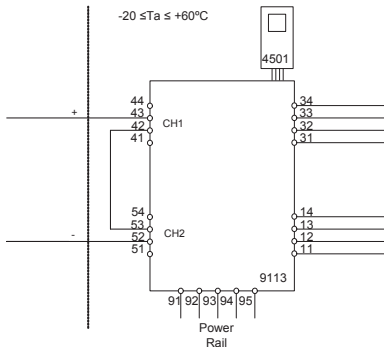

Ex input

CH1 (terminal 43 +)

CH2 (terminal 52 -)

U_o : 17.4 V

I_o : 18.4 mA

P_o : 80 mW

L_o/R_o : 445 μ H/ Ω

(terminal 11,12,13,14)

(terminal 31,32,33,34)

(terminal

91,92,93,94,95)

U_m : 253 V, max 400 Hz

	IIC	IIB	IIA
C_o	0.3 μ F	1.6 μ F	8 μ F
L_o	80 mH	250 mH	600 mH

U_i : 10 V

I_i : 30 mA

C_i : 15 nF

L_i : 1.7 μ H

ATEX Installationstegning

9113

For sikker installation af 9113B skal følgende overholdes: Modulet må kun installeres af kvalificerede personer, som er bekendt med national og international lovgivning, direktiver og standarder i det land, hvor modulet skal installeres. Produktionsår fremgår af de to første cifre i serienummeret.

4501

For installation i zone 2 skal følgende overholdes:
Den aftagelige displayfront til programmering 4501 er udelukkende beregnet til brug på PR electronics moduler. Det er vigtigt, at displayet er ubeskadiget, ikke ombygget eller på anden måde forandret. 4501 må kun anvendes, hvis det er fri for støv og/eller fugt.

ATEX-certifikat:KEMA 07ATEX 0148 X

Mærkning:.....



II (1) G [Ex ia Ga] IIC/IIB/IIA
II 3 G Ex nA nC IIC T4 Gc
II (1) D [Ex ia Da] IIC
I (M1) [Ex ia Ma] I

Standarder: EN 60079-0 : 2009, EN 60079-11 : 2012, EN 60079-15 : 2005
EN 60079-26 : 2007

Ex-område
Zone 0,1,2, 20, 21, 22

Ikke Ex-område
eller Zone 2
-20 ≤ Ta ≤ +60°C

(klemme 11,12,13,14)
(klemme 31,32,33,34)
(klemme 91,92,93,94,95)
U_m: 253 V, max. 400 Hz

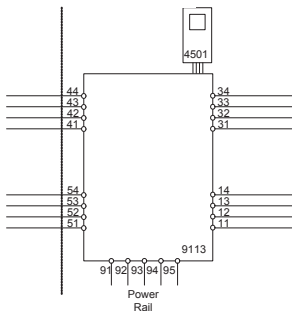

LERBAKKEN 10, 8410 RØNDE DENMARK

Ex-indgang
Kanal 1 (klemme 41,42,43,44)
Kanal 2 (klemme 51,52,53,54)

U_o : 8,7 V
 I_o : 18,4 mA
 P_o : 40 mW
 L_o/R_o : 892 μ H/ Ω

	IIC	IIB	IIA or I
C_o	5 μ F	50 μ F	1000 μ F
L_o	100 mH	300 mH	700 mH

U_i : 10 V
 I_i : 30 mA
 C_i : 30 nF
 L_i : 820 nH

Statusrelæ, klemme (33,34)

Max. spænding: 125 VAC / 110 VDC
 Max. forbrug: 62,5 VA / 32 W
 Max. strøm: 0,5 A AC / 0,3 ADC

Zone 2-installation:

Max. spænding: 32 VAC / 32 VDC
 Max. forbrug: 16 VA / 32 W
 Max. strøm: 0,5 A AC / 1 ADC

Installationsforskrifter:

Installer i forureningsgrad 2, overspændingskategori II som defineret i EN 60664-1.

Monter/demonter ikke stik, når forsyning er tilsluttet og der forefindes en eksplosionsfarlig gasblanding.

Monter/demonter ikke modulet på Power Rail, når der forefindes en eksplosionsfarlig gasblanding.

Afbrud forsyning før udførelse af vedligehold og reparation.

Fortrådning i ubenyttede terminaler er ikke tilladt.

Ved beskyttelsesmetode [Ex ia Da] er parametrene for egensikkerhed for gasgruppe IIB gældende.

For installation i zone 2 skal modulet installeres i et hus, som har beskyttelsestype Ex n eller Ex e, og som giver en IP-beskyttelse på mindst IP54. Kabelforskrutninger og blindstik skal opfylde samme krav.

Ved installation på Power Rail i zone 2, er det kun tilladt at anvende Power Rail type 9400 forsynet af Power Control Unit type 9410 (Type Examination Certificate KEMA 07ATEX0152 X).

LERBAKKEN 10, 8410 RØNDE DENMARK

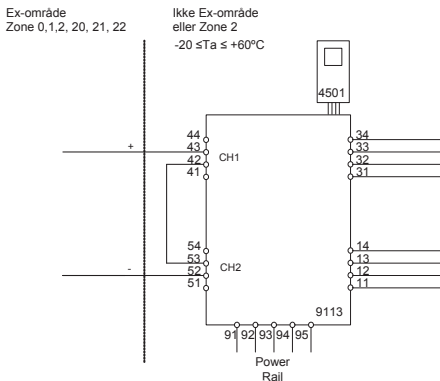

Ex-indgang

Kanal 1 (klemme 43)

Kanal 2 (klemme 52)

$U_{o:}$ 17,4 V

$I_{o:}$ 18,4 mA

$P_{o:}$ 80 mW

L_o/R_o 445 μ H/ Ω

(klemme 11,12,13,14)

(klemme 31,32,33,34)

(klemme 91,92,93,94,95)

U_m : 253 V, max. 400 Hz

	IIC	IIB	IIA or I
C_o	0,3 μ F	1,6 μ F	8 μ F
L_o	80 mH	250 mH	600 mH

U_i : 10 V

I_i : 30 mA

C_i : 15 nF

L_i : 1,7 μ H

FM Installation drawing

9113

For safe installation of 9113B the following must be observed. The module shall only be installed by qualified personnel who are familiar with the national and international laws, directives and standards that apply to this area.

Year of manufacture can be taken from the first two digits in the serial number.

4501

For Installation in Zone 2 / Division 2 the following must be observed.

The 4501 programming module is to be used solely with PRelectronics modules. It is important that the module is undamaged and has not been altered or modified in any way. Only 4501 modules free of dust and moisture shall be installed.

c-FM-us Certificate:3038279

Hazardous Classified Location

Class I/II/III, Division 1, Group A,B,C,D,E,F,G
or Class I, Zone 0/1 Group IIC, [AEx ia] IIC
or Class I, Zone 0/1 Group IIC, [Ex ia] IIC

**Unclassified Location or
Hazardous Classified Location**

Class I, Division 2, Group A,B,C,D T4
or Class I, Zone 2 Group IIC T4

Intrinsically safe apparatus
entity parameters:

$$V_{max}(U_i) \geq V_t(U_o)$$

$$I_{max}(I_i) \geq I_t(I_o)$$

$$P_i \geq P_o$$

$$C_a \geq C_{cable} + C_i$$

$$L_a \geq L_{cable} + L_i$$

The sum of capacitance and inductance of cable and intrinsic safe equipment must be less or equal to C_a and L_a

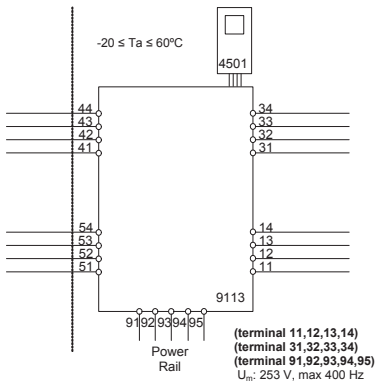

LERBAKKEN 10, 8410 RØNDE DENMARK

Ex input
CH1 (terminal 41,42,43,44)
CH2 (terminal 51,52,53,54)

 Vt (U_o): 8.7 V

 It (I_o): 18.4 mA

 P_o: 40 mW

Lo/Ro 892 μH/Ω

	IIC / Group A,B	IIB / Group C,E,F	IIA / Group D,G
C _a / C _o	5 μF	50 μF	1000 μF
L _s / L _o	100 mH	300 mH	700 mH

 U_i: 10 V

 I_i: 30 mA

 C_i: 30 nF

 L_i: 820 nH

Status Relay. terminal (33,34)

Voltage max: 125 VAC / 110 VDC

Power max: 62.5 VA / 32 W

Current max: 0.5 A AC / 0.3 ADC

Zone 2 installation:

Voltage max: 32 VAC / 32 VDC

Power max: 16 VA / 32 W

Current max: 0.5 A AC / 1 ADC

Installation notes:

The installation and wiring shall be in accordance with the Canadian Electrical Code for Canada and National Electrical Code NFPA 70, Article 500 or 505 for installation in USA.

The module must be supplied from a Power Supply having double or reinforced insulation.

The use of stranded wires is not permitted for mains wiring except when wires are fitted with cable ends.

For installation on the 9400 Power Rail the power must be supplied from Power Control Module Unit 9410.

Install in pollution degree 2, overvoltage category II.

The module must be installed in an enclosure suitable for the environment for which it is used.

For installation in Zone 2 or Division 2, the module must be installed in a suitable outer enclosure according to the regulations in the CEC for Canada or NEC for USA.

The module is galvanic isolated and does not require grounding.

Use 60 / 75 °C Copper Conductors with wire Size AWG: (26-14).

Warning: Substitution of components may impair intrinsic safety.

Warning: To prevent ignition of the explosive atmospheres, disconnect power before servicing and do not separate connectors when energized and an explosive gas mixture is present.

Warning: Do not mount or remove modules from the Power Rail when an explosive gas mixture is present.

Hazardous Classified Location

 Class I/II/III, Division 1, Group A,B,C,D,E,F,G
 or Class I, Zone 0/1 Group IIC, [AEx ia] IIC
 or Class I, Zone 0/1 Group IIC, [Ex ia] IIC

Unclassified Location or
Hazardous Classified Location

 Class I, Division 2, Group A,B,C,D T4
 or Class I, Zone 2 Group IIC T4

 Intrinsically safe apparatus
 entity parameters:

$$V_{\max}(U_i) \geq V_t(U_o)$$

$$I_{\max}(I_i) \geq I_t(I_o)$$

$$P_i \geq P_o$$

$$C_a \geq C_{\text{cable}} + C_i$$

$$L_a \geq L_{\text{cable}} + L_i$$

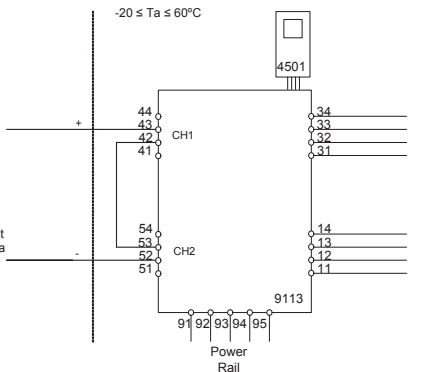
 The sum of capacitance and
 inductance of cable and
 intrinsic safe equipment must
 be less or equal to C_a and L_a

Ex input
CH1 (terminal 42,43)
CH2 (terminal 52,53)
 $V_t(U_o)$: 17.4 V

 $I_t(I_o)$: 18.4 mA

 P_o : 80 mW

 L_o/R_o : 445 $\mu\text{H}/\Omega$

 (terminal 11,12,13,14)
 (terminal 31,32,33,34)
 (terminal 91,92,93,94,95)
 U_m : 253 V, max 400 Hz

	IIC / Group A,B	IIB / Group C,E,F	IIA / Group D,G
C_a / C_o	0.3 μF	1.6 μF	8 μF
L_a / L_o	80 mH	250 mH	600 mH

 U_i : 10 V
 I_i : 30 mA
 C_i : 15 nF
 L_i : 1.7 μH

INMETRO Desenhos para Instalação



Para instalação segura do 9113B o manual seguinte deve ser observado. O módulo deve ser instalado somente por profissionais qualificados que estão familiarizados com as leis nacionais e internacionais, diretrizes e normas que se aplicam a esta área. Ano de fabricação pode ser obtido a partir dos dois primeiros dígitos do número de série.



4501

Para a instalação na Zona 2 o seguinte deve ser observado. O módulo de programação de 4501 deve ser utilizado apenas com os módulos PRelectronics. É importante que o módulo esteja intacto e não tenha sido alterado ou modificado de qualquer maneira. Apenas os módulos 4501 livres de poeira e umidade devem ser instalados.

INMETRO Certificado NCC 12.1310X

Marcas [Ex ia Ga] IIC/IIB/IIA
Ex nA nC IIC T4 Gc
[Ex ia Da] IIIC

Normas IEC60079-15:2005, IEC60079-11:2011, IEC60079-0:2011
IEC60079-26:2006

Área de Risco
Zona 0,1,2, 20, 21, 22

Área de não Risco
ou Zona 2

$-20 \leq T_a \leq +60^{\circ}\text{C}$

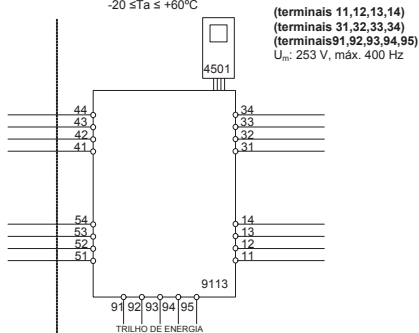

LERBAKKEN 10, 8410 RØNDE DENMARK

Entrada Ex**CN1 (terminais 41,42,43,44)****CN2 (terminais 51,52,53,54)**U₀: 8,7 VI₀: 18.4 mAP₀: 40 mW

Lo/Ro 892 μH/Ω

	IIC	IIB	IIA
C ₀	5 μF	50 μF	1000 μF
L ₀	100 mH	300 mH	700 mH

U_i: 10 VI_i: 30 mAC_i: 30 nFL_i: 820 nH**Relê de Estado terminais (33,34)**

Voltagem máx.: 125 VAC / 110 VDC

Potencia máx.: 62,5 VA / 32 W

Corrente máx.: 0,5 A AC / 0,3 ADC

Instalação Zone 2:

Voltagem máx.: 32 VAC / 32 VDC

Potência máx.: 16 VA / 32 W

Corrente máx.: 0,5 A AC / 1 ADC

Notas de Instalação:

Instalação em grau de poluição 2, categoria de sobretensão II conforme definido no IEC 60664-1
Não separe conectores quando energizado ou quando uma mistura de gás explosivo estiver presente.

Não monte ou remova módulos do trilho de alimentação quando uma mistura explosiva de gás estiver presente.

Desligue a alimentação antes da manutenção.

A fiação de terminais sem uso não é permitida.

A fonte de Loop e terminais de entrada de corrente para o mesmo canal não deve ser aplicada ao mesmo tempo.

Em tipo de proteção [Ex ia Da] os parâmetros para a segurança intrínseca para grupo de gás IIB são aplicáveis.

Para a instalação em Zona 2, o módulo deve ser instalado em um invólucro certificado conforme as normas da série ABNT NBR IEC 60079 que proporcione um grau de proteção de pelo menos IP54. Dispositivos de entrada de cabo e elementos de vedação devem cumprir com os mesmos requisitos.

Para a instalação de trilho de energia na Zona 2, apenas o trilho de alimentação Rail 9400 fornecido pela Unidade de Controle de Potência 9410 é permitido.

LERBAKKEN 10, 8410 RØNDE DENMARK

Área de Risco
Zona 0,1,2, 20, 21, 22

Área de não Risco
ou Zona 2

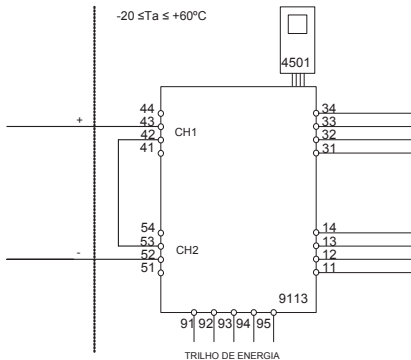

Entrada Ex

CN1 (terminais 43 +)

CN2 (terminais 52 -)

U_o: 17.4 V

I_o: 18,4 mA

P_o: 80 mW

Lo/Ro 445 μH/Ω

(terminais 11,12,13,14)

(terminais 31,32,33,34)

(terminais 91,92,93,94,95)

U_m: 253 V, máx. 400 Hz

	IIC	IIB	IIA
C _o	0,3 μF	1,6 μF	8 μF
L _o	80 mH	250 mH	600 mH

U_i: 10 V

I_i: 30 mA

C_i: 15 nF

L_i: 1,7 μH

SAFETY MANUAL

TEMPERATURE / mA CONVERTER 9113

This safety manual is valid for the following product versions:

9113-004

9113-003

9113-002

0 CONTENTS

1	Observed standards.....	3
2	Acronyms and abbreviations	3
3	Purpose of the product.....	3
4	Assumptions and restrictions for use of the product	4
4.1	Basic safety specifications	4
4.2	Safety accuracy	4
4.2.1	Minimum span	4
4.2.2	Range limitations	4
4.3	Associated equipment.....	4
4.3.1	RTD sensor wiring	4
4.3.2	Sensor errors	5
4.3.3	Process calibration	5
4.3.4	Analogue output	5
4.4	Failure rates	5
4.5	Safe parameterisation.....	5
4.6	Installation in hazardous areas	5
5	Functional specification of the safety function.....	5
6	Functional specification of the non-safety functions.....	5
7	Safety parameters.....	6
8	Hardware and software configuration.....	6
9	Failure category.....	6
10	Periodic proof test procedure	7
11	Procedures to repair or replace the product.....	7
12	Maintenance.....	7
13	Documentation for routing diagram.....	7
13.1	In general	7
13.2	Further explanations	8
13.2.1	Password protection.....	8
13.2.2	Sensor/cable fault information via display front 4501.....	8
13.3	Advanced functions.....	8
13.3.1	Memory (MEM)	8
13.3.2	Display setup (DISP)	8
13.3.3	Password (PASS).....	8
13.3.4	Language (LANG).....	8
13.3.5	Process calibration (CAL)	9
13.3.6	Power rail (RAIL)	9
13.3.7	Simulation (SIM).....	9
13.3.8	Safety integrity level (SIL)	9
14	Safe parameterisation - user responsibility	10
14.1	Safety-related configuration parameters.....	10
14.1.1	Parameters related only to Channel 1	10
14.1.2	Parameters related only to Channel 2 (only for type 9113BB)	13
14.1.3	Parameters related to both channels	13
14.2	Verification procedure.....	13
14.2.1	If no password is set	14
14.2.2	If password is set.....	17
14.2.3	If any parameter is found to be incorrect during verification	17
14.3	Functional test	17

15	Fault reaction and restart condition	17
16	User interface.....	18
16.1	Scrolling help texts in display line 3	18
16.2	Routing diagram	19
16.3	Routing diagram - Advanced settings (ADV.SET).....	21
17	Connections diagram.....	22

1 Observed standards

Standard	Description
IEC 61508	Functional Safety of electrical / electronic / programmable electronic safety-related systems
IEC 61508-2:2000	Part 2: Requirements for electrical / electronic / programmable electronic safety-related systems
IEC 61508-3:1998	Part 3: Software requirements
IEC 61326-3-1:2008	Immunity requirements for safety-related systems

2 Acronyms and abbreviations

Acronym / Abbreviation	Designation	Description
Element		Term defined by IEC 61508 as “part of a subsystem comprising a single component or any group of components that performs one or more element safety functions”
PFD	Probability of Failure on Demand	This is the likelihood of dangerous safety function failures occurring on demand.
PFH	Probability of dangerous Failure per Hour	The term “Probability” is misleading, as IEC 61508 defines a Rate.
SFF	Safe Failure Fraction	Safe Failure Fraction summarises the fraction of failures which lead to a safe state and the fraction of failures which will be detected by diagnostic measures and lead to a defined safety action.
SIF	Safety Integrity Function	Function that provides fault detection (to ensure the necessary safety integrity for the safety functions)
SIL	Safety Integrity Level	The international standard IEC 61508 specifies four discrete safety integrity levels (SIL 1 to SIL 4). Each level corresponds to a specific probability range regarding the failure of a safety function.

3 Purpose of the product

Conversion and scaling of temperature (Pt, Ni and TC) and current signals from hazardous area.

The device can be mounted in the safe area and in zone 2 / div. 2 and receive signals from zone 0, 1, 2, 20, 21 and 22 / Class I/II/III, Div. 1, Gr. A-G.

Error events, including cable breakage, are monitored and signalled via the individual status relay and/or a collective electronic signal via the power rail.

The 9113 has been designed, developed and certified for use in SIL 2 applications according to the requirements of IEC 61508.

4 Assumptions and restrictions for use of the product

4.1 Basic safety specifications

Operational temperature range.....	-20...+60°C
Storage temperature range.....	-20...+85°C
Power supply type, min.....	Double or reinforced
Supply voltage	19.2...31.2 VDC
External loop supply voltage	5...26 VDC + external drop
Mounting area.....	Zone 2 / Division 2 or safe area
Mounting environment.....	Pollution degree 2 or better

4.2 Safety accuracy

The analogue output corresponds to the applied input within the safety accuracy.

Safety accuracy $\pm 2\%$

4.2.1 Minimum span

For temperature measurements, the selected range (OUT.HI - OUT.LO) shall be larger or equal to the values below:

Input type	Minimum span for safety accuracy
Pt100, Pt200, Pt1000	28°C
Pt500, Ni100, Ni120, Ni1000	43°C
Pt50, Pt400, Ni50	57°C
Pt250, Pt300	85°C
Pt20	142°C
Pt10	283°C
TC: E, J, K, L, N, T, U	91°C
TC: B, R, S, W3, W5, LR	153°C

4.2.2 Range limitations

TC type B shall not be used below +400°C

4.3 Associated equipment

4.3.1 RTD sensor wiring

If a 2-wire or a 3-wire connection for RTD is selected, the end user must ensure that the applied sensor wiring does not introduce failures exceeding the requirements for the safety application.

4.3.2 Sensor errors

If Sensor error detection is disabled, if current input range 0...20 mA is selected or if input type Pt10, Pt20, or Pt50 is selected, the end user must ensure that the applied sensor including wiring has a failure rate qualifying it for the safety application without sensor error detection enabled.

For Pt10, Pt20 and Pt50 input types, this only relates to short-circuited sensor detection.

4.3.3 Process calibration

If a process calibration is taken into SIL-mode operation, it is mandatory that the accuracy of the device (and sensor, if applicable) are tested by the end user after SIL-mode is entered, in addition to the normal functional test. Refer to section 14 - Safe parameterisation - user responsibility.

4.3.4 Analogue output

The connected safety PLC shall be able to detect and handle the fault indications on the analogue output of the 9113 converter by having a NAMUR NE43-compliant current input.

4.4 Failure rates

The basic failure rates from the Siemens standard SN 29500 are used as the failure rate database.

Failure rates are constant, wear-out mechanisms are not included.

External power supply failure rates are not included.

4.5 Safe parameterisation

The user is responsible for verifying the correctness of the configuration parameters. (See section 14 Safe parameterisation - user responsibility).

Manual override may not be used for safety applications.

4.6 Installation in hazardous areas

The IECEx Installation drawing, ATEX Installation drawing and FM Installation drawing shall be followed if the products are installed in hazardous areas.

5 Functional specification of the safety function

Conversion of current signals (0...20 mA or 4...20 mA), RTD sensor signals or thermocouple sensor signals from hazardous areas to a 4...20 mA current output signal, in two separately configurable channels, within specified accuracy.

For RTD sensors, cable resistances of up to 50 Ω per wire can be compensated if 3- or 4-wire connection is configured.

For thermocouple sensors, cold junction temperature errors can be compensated, either by an internally mounted temperature sensor, or by an accessory connector with a built-in temperature sensor. The selection of CJC measurement must be done and verified by the end user.

6 Functional specification of the non-safety functions

The status relay (terminal 33 and 34), error signal on power rail (terminal 91) and LED outputs are not suitable for use in any Safety Instrumented Function.

7 Safety parameters

Probability of dangerous Failure per Hour (PFH)	6.10E-08
	Note ¹
Probability of failure on demand (PFD) - 1 year proof test interval	3.96E-04
Proof test interval (10% of loop PFD)	3 years
Safe Failure Fraction	90.7 %
Demand response time	Signal input: < 0.5 seconds Temperature input: < 1.1 seconds
Demand mode	High
Demand rate	3000 seconds
Mean Time To Repair (MTTR)	24 hours
Diagnostic test interval	30 seconds
Hardware Fault Tolerance (HFT)	0
Component Type	B
SIL capability	SIL 2
Description of the "Safe State"	Output \leq 3.6 mA or output \geq 21 mA

Note1: The 9113 contains no lifetime limiting components, therefore the PFH figures are valid for up to 12 years, according to IEC 61508.

8 Hardware and software configuration

All configurations of software and hardware versions are fixed from factory, and cannot be changed by end-user or reseller.

This manual only covers products labelled with the product version (or range of versions) specified on the front page.

9 Failure category

Failure category	Failure rates (1/h)
Fail Safe Detected	0.000E-0
Fail Safe Undetected	2.34E-7
Fail Dangerous Detected	3.67E-7
Fail Dangerous Undetected	6.10E-8

10 Periodic proof test procedure

Step	Action
1	Bypass the safety PLC or take other appropriate action to avoid a false trip
2	Connect a simulator identical to the input setup
3	Apply input value corresponding to 0/100% output range to each channel
4	Observe whether the output channel acts as expected
5	Restore the input terminals to full operation
6	Remove the bypass from the safety PLC or otherwise restore normal operation

This test will detect approximately 95% of possible “du” (dangerous undetected) failures in the device. The proof test is equivalent to the functional test.

11 Procedures to repair or replace the product

Any failures that are detected and that compromise functional safety should be reported to the sales department at PR electronics A/S.

Repair of the device and replacement of circuit breakers must be done by PR electronics A/S only.

12 Maintenance

No maintenance required.

13 Documentation for routing diagram

The routing diagram is shown in section 16.2.

13.1 In general

When configuring the 9113, you will be guided through all parameters and you can choose the settings which fit the application. For each menu there is a scrolling help text which is automatically shown in line 3 on the display.

Configuration is carried out by use of the 3 function keys:

- ⏪ will increase the numerical value or choose the next parameter
- ⏩ will decrease the numerical value or choose the previous parameter
- ⏹ will accept the chosen value and proceed to the next menu

When configuration is completed, the display will return to the default state 1.0.

Pressing and holding ⏹ will return to the previous menu or return to the default state (1.0) without saving the changed values or parameters.

If no key is activated for 1 minute, the display will return to the default state (1.0) without saving the changed values or parameters.

13.2 Further explanations

13.2.1 Password protection

Access to the configuration can be blocked by assigning a password. The password is saved in the device in order to ensure a high degree of protection against unauthorised modifications to the configuration. Default password 2008 allows access to all configuration menus. Password protection is mandatory in SIL applications.

13.2.2 Sensor/cable fault information via display front 4501

When the function is enabled and supported by selected input type, sensor or cable faults are displayed as SE.BR (sensor break) or SE.SH (cable short-circuited). Sensor fault is shown independently for each channel.

In case of sensor or cable fault the backlight flashes. This can be reset by pressing the  key. When the sensor or cable fault has been remedied, the device will return to normal operation.

13.3 Advanced functions

The device gives access to a number of advanced functions which can be reached by answering "Yes" to the point "adv.set".

13.3.1 Memory (MEM)

In the memory menu a non-SIL configuration can be either saved or loaded from the local memory of the 4501 display unit. Choose SAVE to store the current configuration in the 4501 memory. Press LOAD to read a previously stored configuration in the 4501 memory and store it in the device. It is only possible to load a configuration stored from the same type of device and from the same version, or earlier.

13.3.2 Display setup (DISP)

The brightness contrast and the backlight can be adjusted.

Tag numbers with 5 alphanumeric can be entered for both channels.

Functional readout in line 2 (ch.1) and 3 (Ch.2) of the display can be selected: choose between readout of input value, output current or tag no. When selecting "ALT" the readout alternates between input value, output current and tag no.

13.3.3 Password (PASS)

Here you can choose a password between 0000 and 9999 in order to protect the device against unauthorised modifications to the configuration. The device is delivered default without password.

13.3.4 Language (LANG)

In this menu you can choose between 7 different language versions of help texts that will appear in the menu. You can choose between UK, DE, FR, IT, ES, SE and DK.

13.3.5 Process calibration (CAL)

A process calibration can be made by the end user. A known process signal must be applied for both low and high end of the input measurement range. The known input of the applied low end signal must be entered in the CAL.LO menu and confirmed by pressing OK before removing or changing the applied signal to the high end signal. The known input of the applied high end signal must be entered in the CAL.HI menu and confirmed by pressing OK before removing. It is possible to enable or disable the use of the latest process calibration.

13.3.6 Power rail (RAIL)

In this menu it can be chosen if errors in the device are transmitted to the central surveillance in the PR 9410 power control device.

13.3.7 Simulation (SIM)

It is possible to override the actual measured input signal by a simulated value. Only one channel can be simulated at a time. Leaving either of the simulation menus, or disconnecting the 4501 device, will disable the simulation mode and bring the output back to correspond to the actual measured value. Simulation is not possible in SIL-mode.

13.3.8 Safety integrity level (SIL)

See section 14 - Safe parameterisation - user responsibility

14 Safe parameterisation - user responsibility

14.1 Safety-related configuration parameters

14.1.1 Parameters related only to Channel 1

Name	Function
CH1.TYP	Selected input type: TEMP = Temperature CURR = Current
I.RANGE	Selected fixed input range for current measurements (for CH1.TYP = CURR): 0_20 = 0...20 mA (no sensor error detection!) 4_20 = 4...20 mA
CONNEC	Selected sensor connection type for RTD measurements (for SENSOR = Ni or Pt): 2W = 2-wire 3W = 3-wire 4W = 4-wire If 2W or 3W is selected, the end user must ensure that the applied sensor wiring does not introduce failures exceeding the requirements for the safety application.
UNIT	Selected temperature unit (for CH1.TYP = TEMP): °C = degrees Celsius °F = degrees Fahrenheit
SENSOR	Selected temperature sensor type (for CH1.TYP = TEMP): TC = Thermocouple Ni = Ni RTD sensor Pt = Pt RTD sensor
Pt.TYPE	Pt sensor type (for SENSOR = Pt): 10 = Pt10 20 = Pt20 50 = Pt50 100 = Pt100 200 = Pt200 250 = Pt250 300 = Pt300 400 = Pt400 500 = Pt500 1000 = Pt1000 (No short circuit detection!)

Name	Function
Ni.TYPE	Ni sensor type (for SENSOR = Ni): 50 = Ni50 100 = Ni100 120 = Ni120 1000 = Ni1000
TC.TYPE	Thermocouple type (for SENSOR = TC): TC.B = Thermocouple type B TC.E = Thermocouple type E TC.J = Thermocouple type J TC.K = Thermocouple type K TC.L = Thermocouple type L TC.N = Thermocouple type N TC.R = Thermocouple type R TC.S = Thermocouple type S TC.T = Thermocouple type T TC.U = Thermocouple type U TC.W3 = Thermocouple type W3 TC.W5 = Thermocouple type W5 TC.Lr = Thermocouple type Lr
CJC	CJC type for SENSOR = TC: INT = Internal CJC sensor measurement CONN = CJC connector measurement (accessory)
O.RANGE	Fixed output range for current output: 0-20 = 0...20 mA Not valid when EN.SIL = YES (Safety applications) 4-20 = 4...20 mA 20-0 = 20...0 mA Not valid when EN.SIL = YES (Safety applications) 20-4 = 20...4 mA

Name	Function
OUT.ERR	<p>Fixed output value on detected sensor error: NONE = Sensor error detection NOT enabled, output at sensor error is undefined.</p> <p>The end user must ensure that the applied sensor including wiring has a failure rate qualifying it for the safety application without the detection enabled.</p> <p>0 mA = Output is 0 mA at sensor error 3.5 mA = Output is 3.5 mA at sensor error (NE43 downscale) 23 mA = Output is 23 mA at sensor error (NE4 upscale)</p>
OUT.LO	<p>Selected temperature value for 0% output for CH1.TYP = TEMP in units defined by the UNIT parameter (°C or °F)</p> <p>Range is defined by the selected temperature sensor (SENSOR and TC.TYPE, Ni.TYPE or Pt.TYPE), but value must be less than OUT.HI - minimum span.</p>
OUT.HI	<p>Selected temperature value for 100% output for CH1.TYP = TEMP in units defined by the UNIT parameter (°C or °F).</p> <p>Range is defined by the selected temperature sensor (SENSOR and TC.TYPE, Ni.TYPE or Pt.TYPE), but must be larger than OUT.LO + minimum span.</p>
RESP	<p>Analogue output response time in seconds.</p> <p>Range is 0.0 to 60.0 seconds.</p>
USE.CAL	<p>Use the applied process calibration values:</p> <p>NO = The last performed process calibration on Channel1 is not used. The channel operates with accuracy as specified.</p> <p>YES = The last performed process calibration on Channel1 is in operation. The required accuracy must be verified by user.</p> <p>End user must verify by test that the applied process calibration does not introduce failures exceeding the requirements for the safety application.</p>

14.1.2 Parameters related only to Channel 2 (only for type 9113BB)

Name	Function
CH1.TYP	Functions as described for Channel 1 (14.1.1)
I.RANGE	
CONNEC	
UNIT	
SENSOR	
Pt.TYPE	
Ni.TYPE	
TC.TYPE	
CJC	
O.RANGE	
OUT.ERR	
OUT.LO	
OUT.HI	
RESP	
USE.CAL	

14.1.3. Parameters related to both channels

Name	Function
NEW.PAS	Password for protection of the device configuration from un-authorized access. Range from 0 to 9999.

The above safety-related configuration parameters are marked in red text in the routing diagrams and must be verified by the user in a SIL configuration.

14.2. Verification procedure

The verification is done using the display / programming front PR 4501 and following the procedure described below.

14.2.1 If no password is set

	Action	Display shows
1	Press OK	ADV.SET
2	Set (ADV.SET) to Yes and press OK	SETUP
3	Set SETUP to SIL and press OK	EN.SIL
4	Set EN.SIL to YES and press OK	NEW.PAS
5	Set password to a number between 0 and 9999 and press OK (At this time the device starts operating in SIL mode with the entered configuration parameters!)	CONFIG Verify OPEN->LOCK*
6	Press OK to confirm verification of the OPEN->LOCK in the display	CH1.TYP
7	Verify input type for Channel 1 and press OK	I.RANGE
8	Verify fixed input range and press OK (ONLY IF CH1.TYP = CURR)	CONNEC
9	Verify sensor connection type and press OK (ONLY IF SENSOR = Ni or Pt and CH1.TYP = TEMP)	UNIT
10	Verify temperature unit and press OK (ONLY IF CH1.TYP = TEMP)	SENSOR
11	Verify temperature sensor type and press OK (ONLY IF CH1.TYP = TEMP)	Pt.TYPE
12	Verify Pt sensor type and press OK (ONLY IF SENSOR = Pt and CH1.TYP = TEMP)	Ni.TYPE
13	Verify Ni sensor type and press OK (ONLY IF SENSOR = Ni and CH1.TYP = TEMP)	TC.TYPE
14	Verify Thermocouple type and press OK (ONLY IF SENSOR = TC and CH1.TYP = TEMP)	CJC

* Open is shown briefly in the display.

	Action	Display shows
15	Verify CJC type and press OK (ONLY IF SENSOR = TC and CH1.TYP = TEMP)	O.RANGE
16	Verify fixed output range and press OK	OUT.ERR
17	Verify fixed output value on detected sensor error and press OK (ONLY IF CH1.TYP = TEMP, or IF I.RANGE = 4-20 mA)	OUT.LO
18	Verify temperature for 0% output and press OK (ONLY IF CH1.TYP = TEMP)	OUT.HI
19	Verify temperature for 100% output and press OK (ONLY IF CH1.TYP = TEMP)	RESP
20	Verify analogue output response time and press OK	CH2.TYP
21	Verify input type for Channel 2 and press OK	I.RANGE
22	Verify fixed input range and press OK (ONLY IF CH2.TYP = CURR)	CONNEC
23	Verify sensor connection type and press OK (ONLY IF SENSOR = Ni or Pt and CH2.TYP = TEMP)	UNIT
24	Verify temperature unit and press OK (ONLY IF CH2.TYP = TEMP)	SENSOR
25	Verify temperature sensor type and press OK (ONLY IF CH2.TYP = TEMP)	Pt.TYPE
26	Verify Pt sensor type and press OK (ONLY IF SENSOR = Pt and CH2.TYP = TEMP)	Ni.TYPE

	Action	Display shows
27	Verify Ni sensor type and press OK (ONLY IF SENSOR = Ni and CH2.TYP = TEMP)	TC.TYPE
28	Verify Thermocouple type and press OK (ONLY IF SENSOR = TC and CH2.TYP = TEMP)	CJC
29	Verify CJC type and press OK (ONLY IF SENSOR = TC and CH2.TYP = TEMP)	O.RANGE
30	Verify fixed output range for current output	OUT.ERR
31	Verify fixed output value on detected sensor error and press OK (ONLY IF CH2.TYP = TEMP, or IF I.RANGE = 4-20 mA or 20-4 mA)	OUT.LO
32	Verify temperature for 0% output and press OK (ONLY IF CH2.TYP = TEMP)	OUT.HI
33	Verify temperature for 100% output and press OK (ONLY IF CH2.TYP = TEMP)	RESP
34	Verify analogue output response time and press OK	CH1.CAL
35	Verify the use of applied process calibration values for Channel 1 and press OK	CH2.CAL
36	Verify the use of applied process calibration values for Channel 2 and press OK	PASSW.
37	Verify password and press OK	SIL.OK
38	Verify SIL mode within 1 second	

14.2.2 If password is set

	Action	Display shows
1	Press OK	PASSW
2	Enter password and press OK	ADV.SET
3	Set ADV.SET to Yes and press OK	SETUP
4	Set SETUP to SIL and press OK	EN.SIL
5	Set EN.SIL to YES and press OK (At this time the device starts operating in SIL mode with the entered configuration parameters!)	CONFIG Verify OPEN->LOCK*
6 to 38	As step 6 to 38 for 14.2.1	As step 6 to 38 for 14.2.1

* Open is shown briefly in the display

14.2.3 If any parameter is found to be incorrect during verification

Remove SIL-mode (by entering the password and selecting SIL-mode OFF).

Go through the setup menu and correct the parameter(s).

Repeat step 1 to 38 (with correct parameters).

14.3 Functional test

The user is responsible to make a functional test after verification of the safety parameters. The procedure for periodic proof test described in section 10 shall be used.

In addition, if a process calibration is taken into SIL-mode operation (refer to section 13.3 - Advanced functions), it is mandatory that the accuracy of the device (and sensor, if applicable) are tested.

15 Fault reaction and restart condition

When the 9113 detects a fault the output will go to Safe State, in which the output will go to “de-energised”.

If the fault is application-specific (cable error detection) the 9113 will restart when the fault has been corrected.

For device faults there are 2 ways of bringing the device out of Safe State.

1. Power cycle the device.
2. Bring the device out of SIL mode (choose “NO” in the menu point “EN.SIL”), and set it back to SIL mode again (choose “YES” in the menu point “EN.SIL” and verify the configuration).

16 User interface

16.1 Scrolling help texts in display line 3

- | | | | |
|------|--|------|---|
| [01] | Set correct password | [17] | Enter SIL setup |
| [02] | Enter advanced setup menu? | | Enter simulation mode |
| [03] | Select temperature input | | Enter RAIL setup |
| | Select current input | | Perform process calibration |
| [04] | Select 0-20 mA input range | | Enter language setup |
| | Select 4-20 mA input range | | Enter password setup |
| [05] | Select TC sensor type | | Enter display setup |
| | Select Ni sensor type | | Perform memory operations |
| | Select Pt sensor type | [18] | Load saved configuration into 9113 |
| [06] | Select Pt10 sensor type | | Save 9113 configuration in 4501 |
| | Select Pt20 sensor type | [19] | Adjust LCD contrast |
| | Select Pt50 sensor type | [20] | Adjust LCD backlight |
| | Select Pt100 sensor type | [21] | Write a 5-character channel TAG |
| | Select Pt200 sensor type | [22] | Show analogue input value in display |
| | Select Pt250 sensor type | | Show analogue output value in display |
| | Select Pt300 sensor type | | Show TAG in display |
| | Select Pt400 sensor type | | Alternate shown information in display |
| | Select Pt500 sensor type | [23] | Enable password protection? |
| | Select Pt1000 sensor type | [24] | Set new password |
| [07] | Select Ni50 sensor type | [25] | Select language |
| | Select Ni100 sensor type | [26] | Select channel to calibrate |
| | Select Ni120 sensor type | [27] | Calibrate input low to process value? |
| | Select Ni1000 sensor type | [28] | Set value for low calibration point |
| [08] | Select TC-B sensor type | [29] | Calibrate input high to process value? |
| | Select TC-E sensor type | [30] | Set value for high calibration point |
| | Select TC-J sensor type | [31] | Use process calibration values? |
| | Select TC-K sensor type | [32] | Select channel to simulate |
| | Select TC-L sensor type | [33] | Set the input simulation value |
| | Select TC-N sensor type | [34] | Enable SIL configuration lock? |
| | Select TC-R sensor type | | 0-20 mA is not a valid output range for SIL operation |
| | Select TC-S sensor type | [35] | Set Analog output response time in seconds |
| | Select TC-T sensor type | [36] | Select internal temperature sensor |
| | Select TC-U sensor type | | Select CJC connector (accessory) |
| | Select TC-W3 sensor type | [37] | ...is channel using process-compensated calibration data? |
| | Select TC-W5 sensor type | [38] | Configuration SIL status (Open / Locked) |
| | Select TC-Lr sensor type | [40] | Sensor wire breakage |
| [09] | Select 2-wire sensor connection | [41] | Sensor short circuit |
| | Select 3-wire sensor connection | [42] | Input underrange |
| | Select 4-wire sensor connection | [43] | Input overrange |
| [11] | Select Celsius as temperature unit | [44] | Input error - check input connections and reset power |
| | Select Fahrenheit as temperature unit | [45] | Output error - check connections and reset power |
| [12] | Select 0-20 mA output range | [46] | Flash memory error - check configuration |
| | Select 4-20 mA output range | [47] | Invalid configuration type or version |
| | Select 20-0 mA output range | [48] | Hardware error |
| | Select 20-4 mA output range | [49] | CJC sensor error - check device temperature |
| [13] | Select no error action - output undefined at error | [50] | CJC error - check CJC connector block |
| | Select downscale at error | [51] | No communication |
| | Select NAMUR NE43 downscale at error | | |
| | Select NAMUR NE43 upscale at error | | |
| [14] | Set temperature for analogue output low | | |
| [15] | Set temperature for analogue output high | | |
| [16] | Enable Rail status signal output? | | |

16.2 Routing diagram

Power up If no key is activated for 1 minute, the display will return to the default state 1.0 without saving configuration changes.

⊕ Increase value / choose next parameter

⊖ Decrease value / choose previous parameter

⊙ Accept the chosen value and proceed to the next menu

⊙ Hold ⊙ Back to previous menu / return to menu 1.0 without saving



1.0

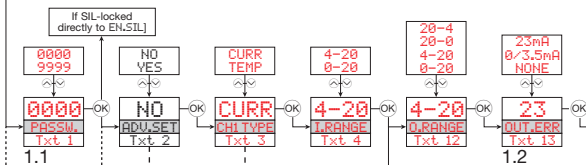

1.0 = Default state. Line 1 shows input status, line 2 and 3 show analogue input / output value or TAG No. and units, and line 4 shows status for communication and whether the device is SIL-locked. Static dot = SIL-locked and flashing dot = not SIL-locked.

1.1 = Only if password-protected.

1.2 = Not valid for 0...20 mA input signal.

1.3 = Only if input signal is temperature. Min. and max. acc. to selected sensor type.

1.4 = Only if the configuration is not protected by a password.

Red text signifies safety parameters in a SIL configuration.

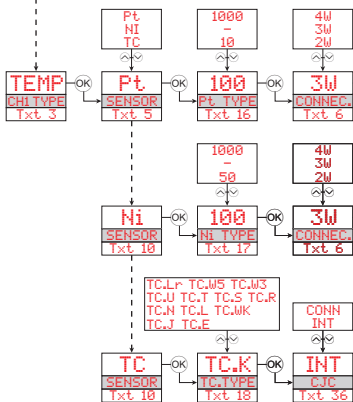

Continued on the page
Routing diagram ADV.SET



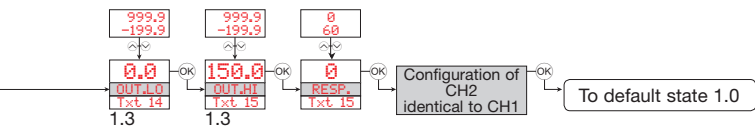

16.3 Routing diagram - Advanced settings (ADV.SET)

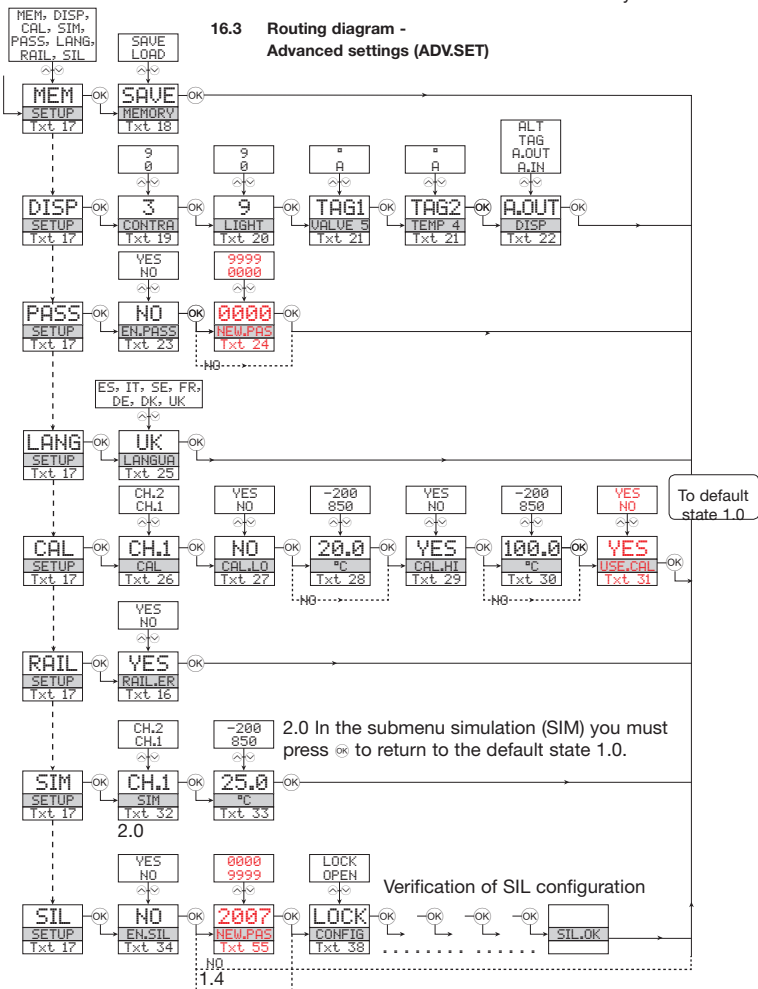

17 Connections diagram

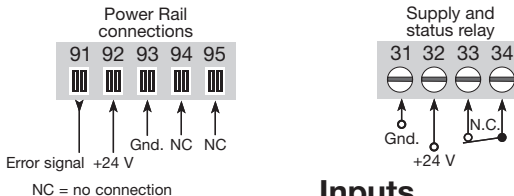

Inputs

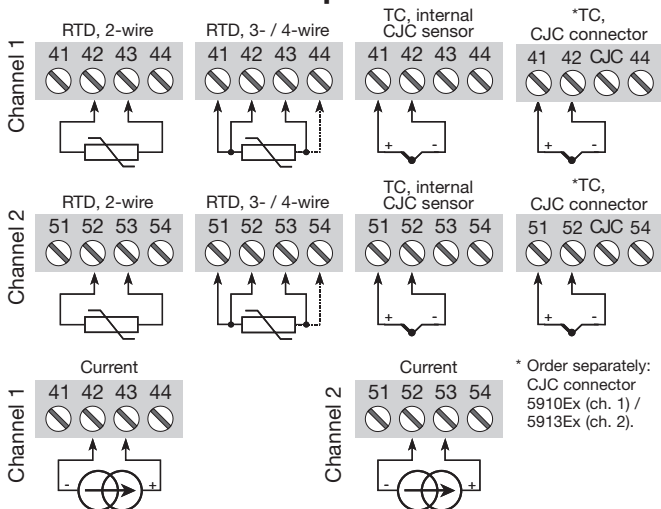

Outputs





Displays Programmable displays with a wide selection of inputs and outputs for display of temperature, volume and weight, etc. Feature linearization, scaling, and difference measurement functions for programming via PReset software.



Ex interfaces Interfaces for analog and digital signals as well as HART® signals between sensors / I/P converters / frequency signals and control systems in Ex zone 0, 1 & 2 and for some devices in zone 20, 21 & 22.



Isolation Galvanic isolators for analog and digital signals as well as HART® signals. A wide product range with both loop-powered and universal isolators featuring linearization, inversion, and scaling of output signals.





























Temperature A wide selection of transmitters for DIN form B mounting and DIN rail devices with analog and digital bus communication ranging from application-specific to universal transmitters.



Universal PC or front programmable devices with universal options for input, output and supply. This range offers a number of advanced features such as process calibration, linearization and auto-diagnosis.



- 

www.preelectronics.fr

sales-fr@preelectronics.com
- 

www.preelectronics.de

sales-de@preelectronics.com
- 

www.preelectronics.es

sales-es@preelectronics.com
- 

www.preelectronics.it

sales-it@preelectronics.com
- 

www.preelectronics.se

sales-se@preelectronics.com
- 

www.preelectronics.com

sales-uk@preelectronics.com
- 

www.preelectronics.com

sales-us@preelectronics.com
- 

www.preelectronics.cn

sales-cn@preelectronics.com
- 

www.preelectronics.be

sales-be@preelectronics.com

Head office

Denmark
 PR electronics A/S
 Lerbakken 10
 DK-8410 Rønde

www.preelectronics.com
sales-dk@preelectronics.com
 tel. +45 86 37 26 77
 fax +45 86 37 30 85



QUALITY SYSTEM AND ENVIRONMENTAL MANAGEMENT SYSTEM
 DS/EN ISO 9001
 DS/EN ISO 14001

